

# Northstar RIM Tach 8500 10 Steps to Installation

## J – Wheel (Spoke Style Wheel)



# Mill Duty – High Performance & Rugged



- Most Reliable magneto-resistive digital tach on the market today
- Ductile Iron Housing & Stainless Steel Sensor Modules
- Bearingless design
- Replaceable sensors “on the run” & no gap adjustments.

# Styles of Wheels

- RIM TACH 8500's have 4 different wheel choices.
- Each wheel has it's own installation method to ensure proper alignment with the sensor
- Each has a specific bore range.

“J Wheel”  
or  
Spoke Wheel

0.675" - 1.25" ID

“K Wheel”  
or  
Clamp Wheel

1.375" - 3.250" ID

Set Screw  
Wheel

3.256" - 4.50" ID

End of Shaft  
Wheel

1.125", 2.125", 2.375" & 2.875" ID



# Important Installation Notes & Cautions!

- Pulse wheels are precision machined and magnetized. Care should be taken when handling. If the wheel comes with a protective band on it, do not remove until ready to install it.



Caution must be used when handling the pulse wheel assembly. The surface of the pulse wheel outer rim is sensitive to scratches and impacts. The magnetic properties of the pulse wheel material can also be distorted or erased by exposure to strong magnetic fields.

- The RIM TACH 8500 sensors (either single or dual) are the last components to be installed. The cavity which they are installed is used to gain access to the wheel for positioning. Install sensor modules in very last step.
- If you are replacing on old unit or just the sensor module, use the new hardware that is packaged with the new Sensor. Some older designs had thicker flanges which utilized longer hardware. These longer fasteners used with the thinner flange will “bottom out” and not secure the sensor module properly.



# Step 1

## Unpacking



- Inspect shipping container and unpack parts.
- Verify all components, accessories and manual were received.
- Become familiar with instruction manual, various parts and any warnings or cautions.
- Review Figure 4 of instruction manual to review parts breakdown.

## Step 2 Inspection



- Rim Tach 8500 is designed to be mounted on a 8.5 inch dia. 180 NEMA C-face flange.
- Inspect C-face, motor face and shaft for damage or paint. Remove paint, dirt and other debris.
- Apply a thin coat of corrosion inhibitor or oil to motor face and shaft.

## Step 3 Insert mounting Studs

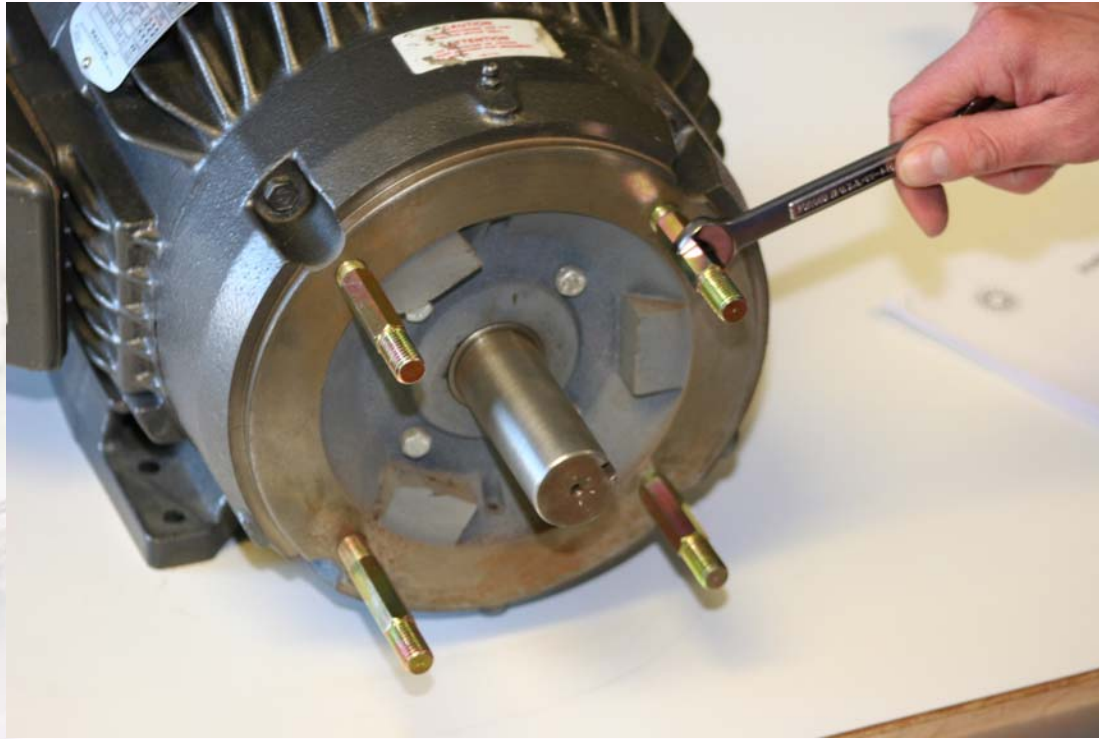

- Insert (4) 1/2-12 plated mounting studs into the motor frame.
- Torque to a nominal 60 Ft-lbs.

## Step 4

# Install Spoke Style Wheel



- Slide spoke pulse wheel onto motor shaft so that “Z” marker or sticker “THIS SIDE OUT” is visible from the face.
- Do not worry about positioning or tightening the wheel at this point. Pulse wheel will be positioned and secured in step 8 A.



## Step 5

### Position RIM 8500 housing

- Determine which of two orientations of the RIM 8500 housing is best for your application.
- Sensors Horizontal or Vertical
- Ensure that the condensation drains for that position is located at the bottom of the housing. If not, rotate housing 180 degrees.

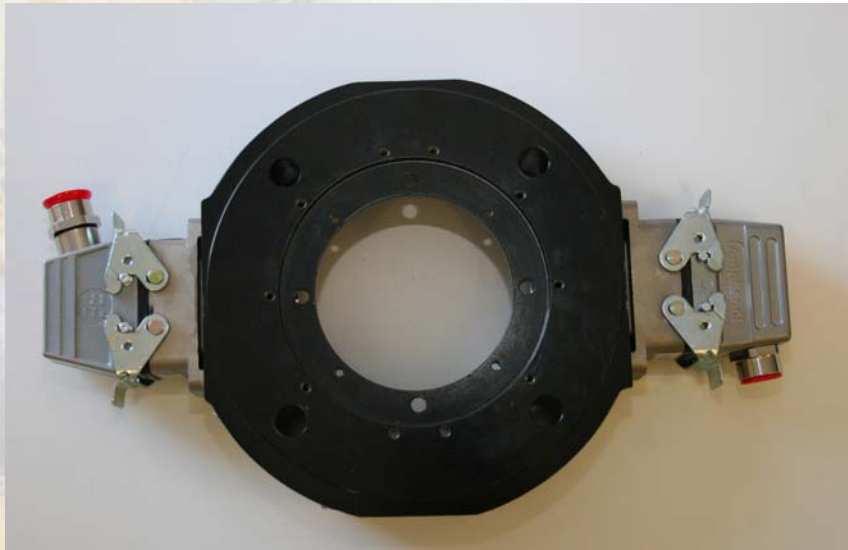

## Step 6

# Install RIM 8500 housing

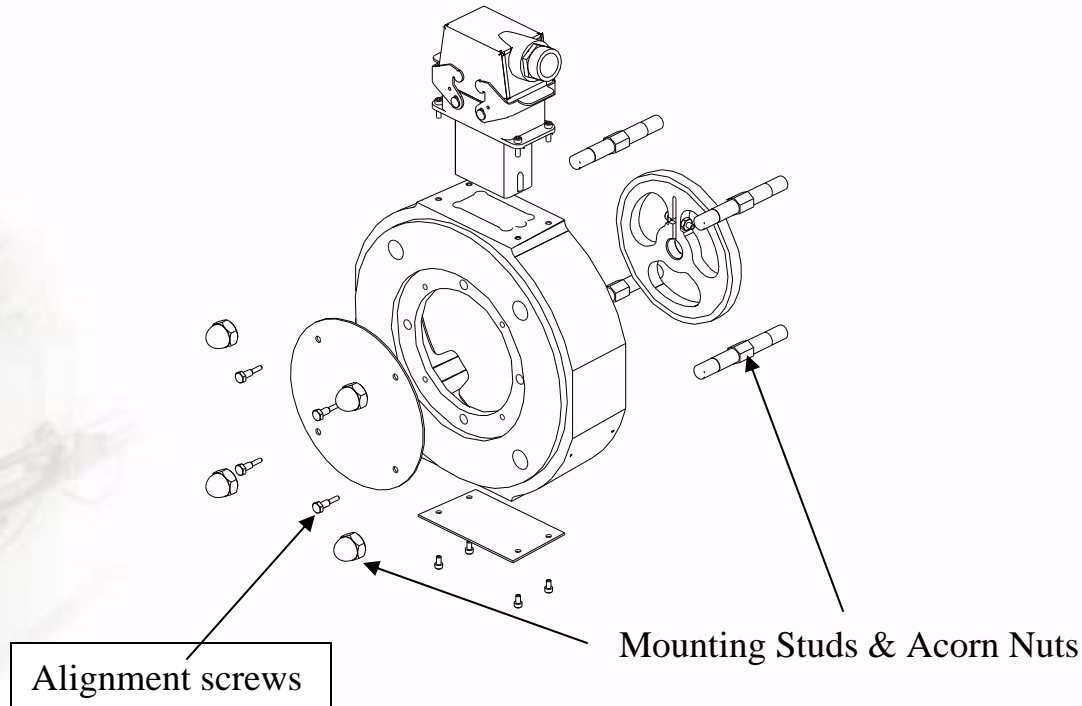

- Referencing the above figure, locate the (4) 10-32 UNC alignment screws or end of shaft cover screws. These are used in the next step to position the pulse wheel under the sensor module.

## Step 6 Cont.

### Install RIM 8500 housing

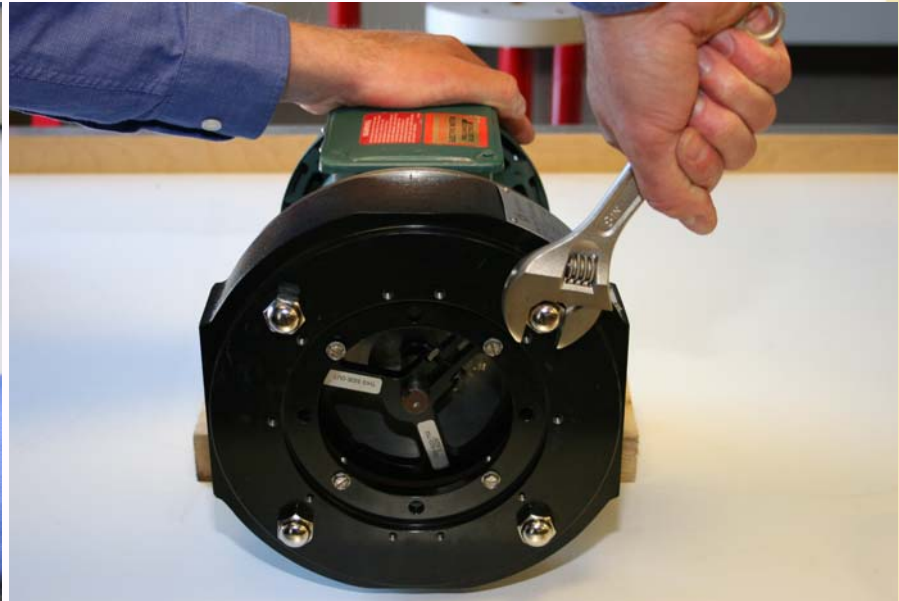

- Without the cover, insert the (4) alignment screws all the way into the 8500 housing. These will be used as mechanical stops to position the pulse wheel.
- Place the 8500 housing on the (4) ½-12 mounting studs and slide to motor face. Tap lightly with hand or rubber hammer to seat housing on C-face.
- Insert (4) ½ -13 acorn cap nuts onto mounting studs. Tighten nuts in an alternating star pattern. Torque to 50 Ft-lbs.

## Step 7

### Position & secure spoke pulse wheel

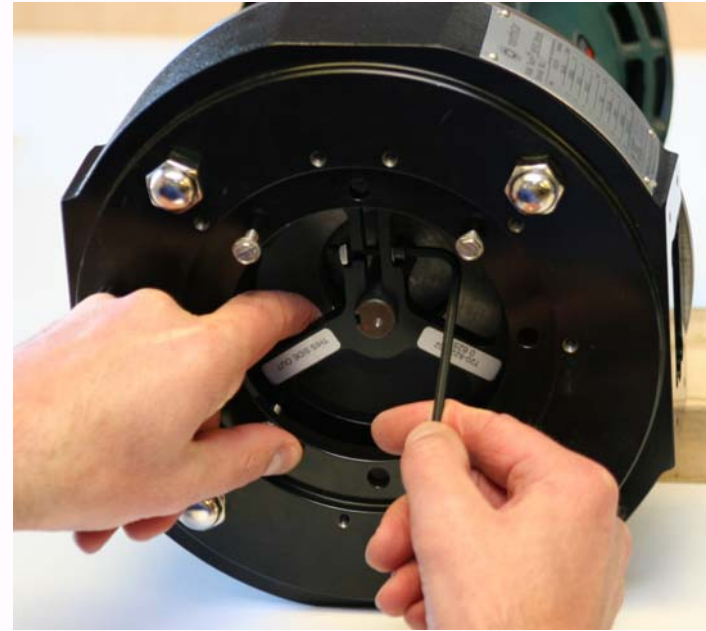
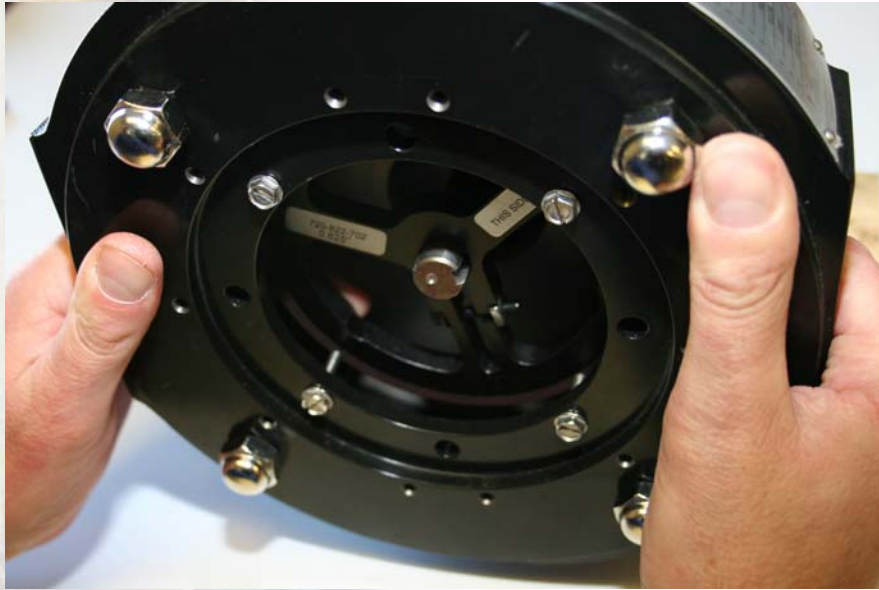

- Pull pulse wheel forward so it touches all four alignment screws in housing.
- Using a 9/64 hex wrench, tighten the # 8 socket head cap screw to a nominal 5 Ft-lbs. One full turn after the clamp begins to grip the shaft will provide full holding power.
- Do not over tighten the pulse wheel.



## Step 8

### Secure end of shaft cover

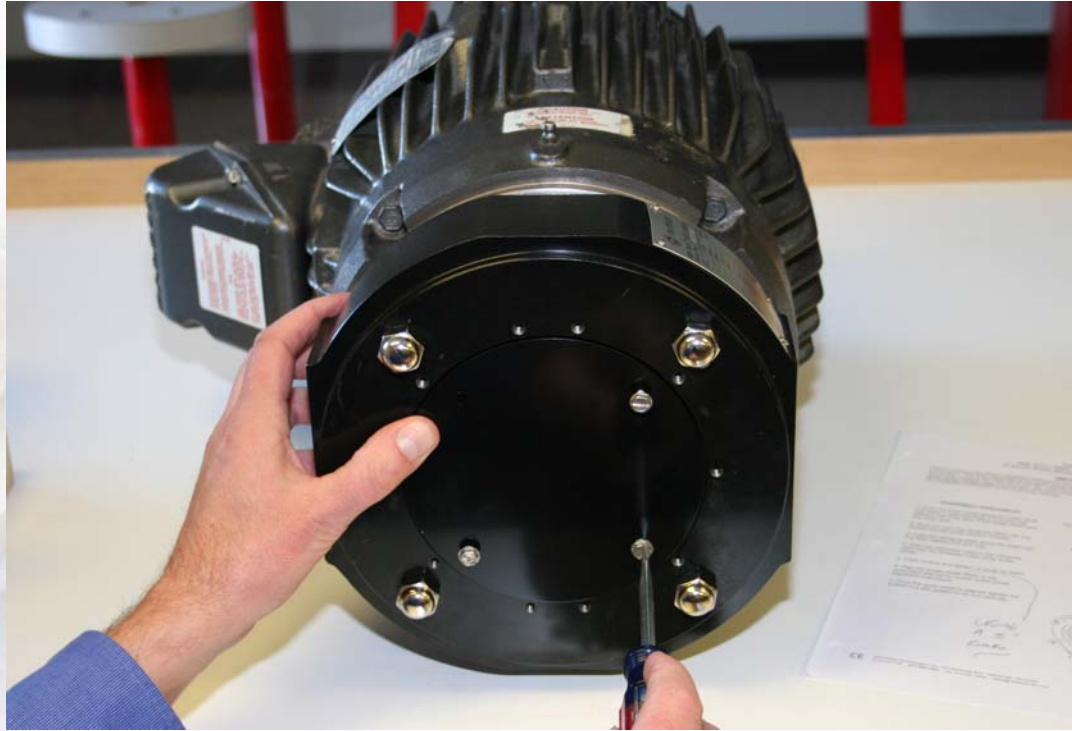

- Once the wheel is secured on the shaft, remove the (4) 10-32 UNC alignment screws installed in step 1 from the 8500 housing.
- Position the end of shaft cover on the housing and re-install the (4) 10-32 UNC screws to secure the cover.

## Step 9

# Wire Sensor Module



- After wiring the signal cable to the connector hood, install the connector hood on the sensor module.
- Snap the connector latches in place to secure.

# Step 10

## Install Sensor Module

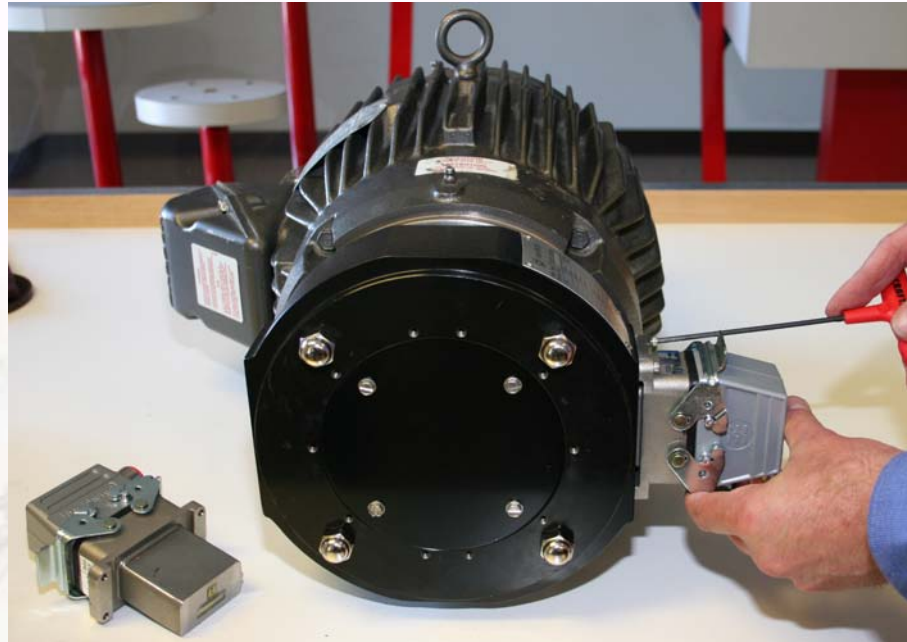

- Insert sensor module/s into the housing. The sensor and housing are keyed to ensure proper orientation and installation of the sensor.
- Locate four socket head cap screws that came with the hardware kit. Insert them through the clearance holes in sensor module and into the tapped holes in housing. Tighten to a nominal 5 In-lbs.
- The RIM Tach 8500 allows up to 2 sensor modules. The RIM Tach 8500 Quad allows up to 4 sensor modules.

## Complete RIM Tach 8500



### •Other training modules available

- RIM Tach 8500 “K Wheel”
- RIM Tach 8500 “End-of-Shaft Wheel”
- RIM Tach “Shaft Grounding Brush”